



**ATTENTION**

If any components of this unit are broken,  
or if the unit does not operate properly,  
please contact LEM Products at

**1-877-536-7763**

For more great products or a free catalog  
log onto [www.lemproducts.com](http://www.lemproducts.com)



# #8 Electric Meat Grinder

**MODEL #1113**

**120V~60Hz, 575W**



LEM Products  
109 May Drive • Harrison, OH 45030  
877-536-7763  
[www.lemproducts.com](http://www.lemproducts.com)

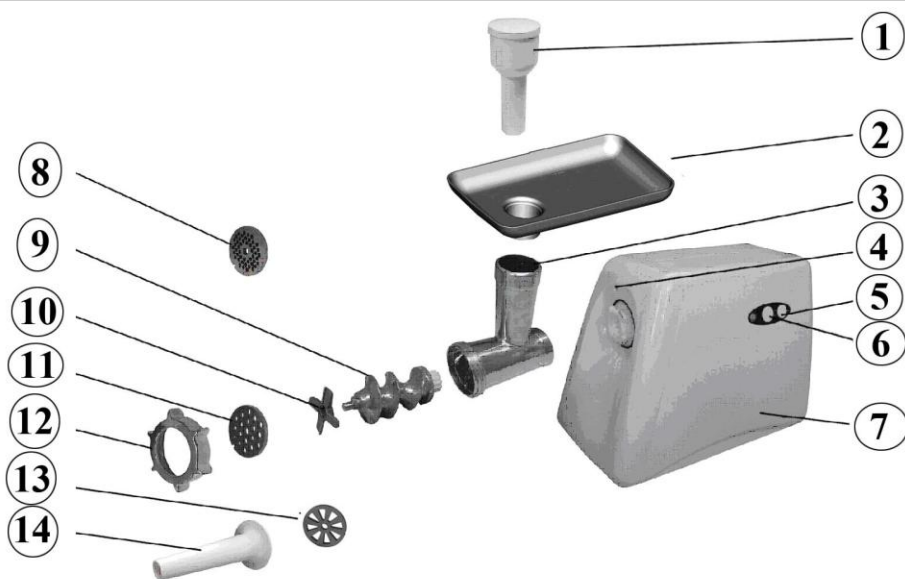

## #8 ELECTRIC MEAT GRINDER

### SKU #1113

LETTER	DESCRIPTION	LETTER	DESCRIPTION
1	MEAT STOMPER	8	FINE GRINDING PLATE
2	MEAT PAN	9	WORM GEAR/AUGER
3	GRINDER HEAD	10	GRINDER KNIFE
4	RELEASE BUTTON	11	COARSE GRINDING PLATE
5	REVERSE BUTTON	12	RETAINING RING
6	ON/OFF SWITCH	13	STUFFING PLATE
7	MOTOR HOUSING	14	STUFFING TUBE

### IMPORTANT WARRANTY INFORMATION BELOW: PLEASE READ, FILL OUT AND RETURN ENCLOSED WARRANTY CARD TO ENSURE WARRANTY COVERAGE.

**THIS WARRANTY COVERS LEM PRODUCTS**

**#8 575 WATT ELECTRIC MEAT GRINDER**

**THE WARRANTY IS EXTENDED TO THE ORIGINAL PURCHASER ONLY.**

**WARRANTY DURATION:** This product is warranted to the original purchaser for a period of one (1) year from the original purchase date. **EACH UNIT COMES WITH A WARRANTY CARD, WHICH MUST BE FILLED OUT COMPLETELY AND RETURNED IMMEDIATELY, WITH A COPY OF THE PURCHASING RECEIPT. FAILURE TO RETURN YOUR WARRANTY CARD WILL LIMIT WARRANTY TO 90 DAYS WITH PROOF OF PURCHASE.**

**WARRANTY COVERAGE:** This product is warranted against defective materials or workmanship. The warranty is void if the product has been damaged by accident, misuse, neglect, modification or improper service or repairs by unauthorized personnel. It is also void if damaged in shipment or by other causes not arising out of defects in the materials or workmanship. This warranty does not extend to any units which have been in violation of written instructions furnished, or to units which have been altered or modified.

**WARRANTY DISCLAIMERS:** This warranty is in lieu of all warranties expressed or implied, and no representative or person is authorized to assume any other liability in connection with the sale of our products. There shall be no claims for defects or failure of performance under any theory of sort, contract or commercial law including, but not limited to negligence, gross negligence, strict liability or breach of contract.

The manufacturer declines all responsibility for damage to persons, things or animals arising from the failure to comply with the norms contained in this manual. The manufacturer reserves the right to make modifications at anytime to the models while maintaining the main characteristics described herein. The manufacturer also declines all responsibility for any errors in compiling this manual.

**WARRANTY PERFORMANCE:** During the above one year warranty period, a product with a defect will either be repaired or replaced after the product has been inspected by an LEM Service Technician. **NO PRODUCT WILL BE EVALUATED UNLESS THE ORIGINAL SALES RECEIPT OR THE WARRANTY CARD IS ON FILE.** The repaired product will be in warranty for the balance of the one year warranty period. No charge will be made for such repair or replacement.

**IMPORTANT NOTICE:** If any parts are missing or defective, please contact our Customer Service Department for assistance at 877-536-7763. (M-F 8:30am to 4:30pm EST) **DO NOT RETURN TO THE STORE WHERE THE ITEM WAS PURCHASED.**

#### LEM PRODUCTS MERCHANDISE RETURN POLICY WARRANTY SERVICE:

To obtain service under terms of this warranty, please contact us at 877-536-7763 to obtain authorization prior to returning the merchandise. No merchandise will be accepted without prior authorization. Please return the product pre-paid in the original packaging if possible, enclose a copy of your receipt, (Keep a copy of your proof-of purchase for your records.) and include a written explanation of the issue. Ship to LEM Products, 107 May Drive, Harrison, OH 45030.

LEM Products is not responsible for damage incurred in shipping, make certain to pack product properly. Return shipping charges are the responsibility of the purchaser. Packages returned to LEM should be insured for the value of the product to cover any damages that may occur during shipping.





## Tips

- ◆ Cord storage is under motor housing.
- ◆ If the grinder is locked, turn grinder off and press the reverse button. If this does not unlock the grinder, turn the unit off, unplug the electrical cord from the outlet and disassemble the grinder head and remove the obstruction. Reassemble and continue grinding.

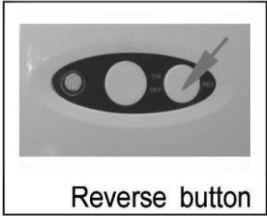

## IMPORTANT SAFEGUARDS

When using electrical appliances, basic safety precautions should always be followed including the following:

1. Read and follow all instructions before using the grinder.
2. To protect against risk of electrical shock do not submerge in water or other liquid. Use a moist cloth to clean the motor housing.
3. Close supervision is necessary when any appliance is used by or near children.
4. Unplug from outlet when not in use, before putting on or taking off parts, and before cleaning.
5. Avoid contacting moving parts.
6. Do not operate any appliance with a damaged cord or plug or after the appliance malfunctions, or is dropped or damaged in any manner. Return appliance to the nearest authorized service facility for examination, repair or electrical or mechanical adjustment.
7. The use of attachments not sold by the manufacturer is not recommended and may cause fire, electric shock or injury.
8. Do not use outdoors.
9. Do not allow cord to hang over edge of table or counter.
10. Never feed food by hand. Always use a meat stomper.
11. Do not use fingers to scrape food away from grinding plate while appliance is operating. Injury may result.
12. Thoroughly hand-wash all grinder parts in warm soapy water prior to use.
13. Never run the grinder unattended.
14. Do not attempt to grind bones, nuts or other hard items.
15. This appliance has a polarized plug (one blade is wider than the other.) To reduce the risk of electrical shock, this plug will fit in a polarized outlet, only one way. If the plug does not fit fully into the outlet reverse the plug. If it still does not fit, contact a qualified electrician. Do not modify the plug in any way.

## How to clean your grinder:

Meat left behind in the **grinder head** may be removed by passing a slice of bread through the **grinder head**.

1. Before clean up of the grinder, switch the appliance off and unplug from electrical socket.
2. Remove the **meat stomper** and **meat tray**.
3. Press the release button and turn the **grinder head** in the direction of unlock.
4. Unscrew the **retaining ring** and remove all parts from the **grinder head**. Hand wash in warm soapy water. Grinder parts are not dishwasher safe. **CLEAN IMMEDIATELY AFTER USE.**
5. Rinse with clear hot water and hand-dry **IMMEDIATELY.**
6. We advise you to lubricate the knife and the grinding plates with silicon spray (available at LEM Products.)

## SAVE THESE INSTRUCTIONS

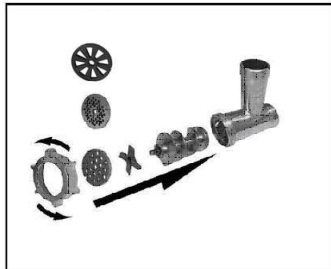

### Grinder Assembly

1. Attach the **grinder head** to the motor housing. It will be necessary to push the release button (#4) when putting the head on the motor.
2. Insert the **worm gear/auger** into the grinder head, the geared end first.
3. Place the **grinder knife** onto the **auger stud**. (The cutting edges should be facing out and flat against the grinder plate when properly installed.)
4. Place the **medium or coarse grinding plate** (depending on the consistency you prefer) onto the **worm gear/auger**. (Make sure the notches on the grinder plate are matched to the locator pin in the grinder head.)
5. Screw the **retaining ring** onto the **grinder head** until it is firmly tightened.
6. Place the **meat tray** on the upright part of the **grinder head**.
7. Now the grinder is ready for grinding.

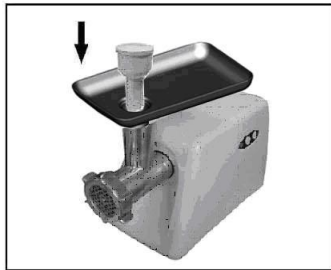
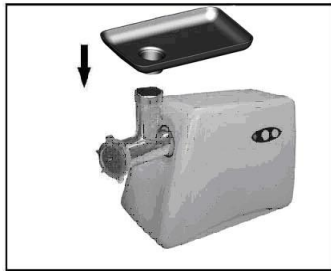

### Grinding

Cut the meat into 4" x 3/4" strips. Make sure to remove all bones, gristle and sinew. Put the meat in the **meat tray**. Turn on the grinder. Use the **meat stomper** to gently push the meat into the **grinder head**. Do not force the meat too quickly, allow the grinder to do the job.

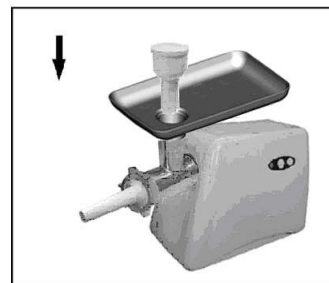
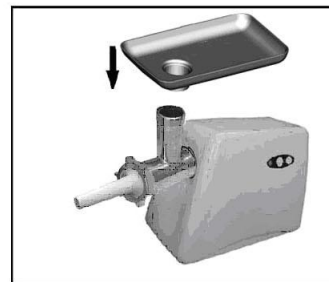
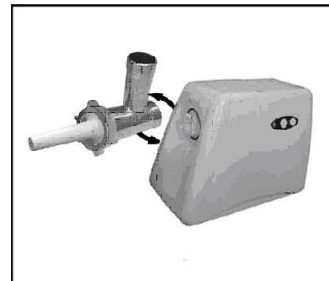
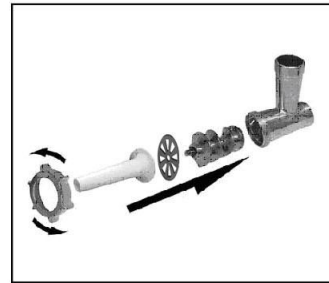

### Stuffing Sausage

1. Grind the meat.
2. Attach the **grinder head** to the **motor housing**.
3. Insert the **worm gear/auger** into the **grinder head**, the geared end first.
4. Place the knife on the square of **auger stud**, put the **stuffing plate** (or other plate depending on the consistency you are wanting) on the auger stud pin. (Make sure the notch in the grinder plate is matched to the locator pin in the grinder head.)
5. Place the **stuffing tube** in the **retaining ring** and screw the ring on the **grinder head**.
6. Place the **meat tray** on the upright part of the **grinder head**.
7. Now the grinder is ready for stuffing sausages.

### Making Sausages

Slide casing of choice onto **stuffing tube**. Mix the course ground meat with the seasonings and add to the **meat tray**. Turn on grinder. Use the **meat stomper** to gently push the meat into the **grinder head**. Do not force the meat too quickly, allow the grinder to do the job.

**NOTE: Never operate the grinder without the grinder knife and one of the grinder plates in the head. Doing so may force meat back into the motor.**